

•

•

•

( / )  
KCL KVL  
VCR

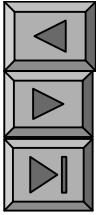

3 1



XCL KVL

2010 3 3

3



G

“(Graph)”

5

8

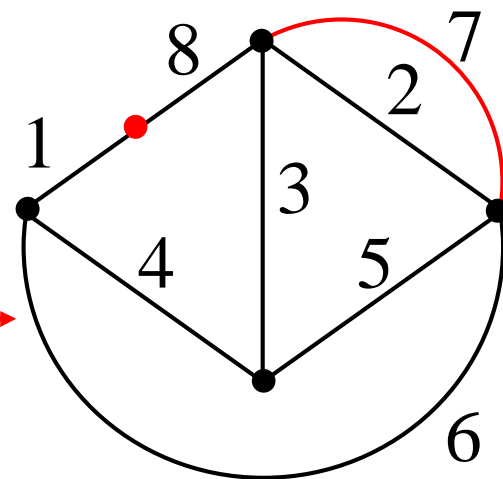
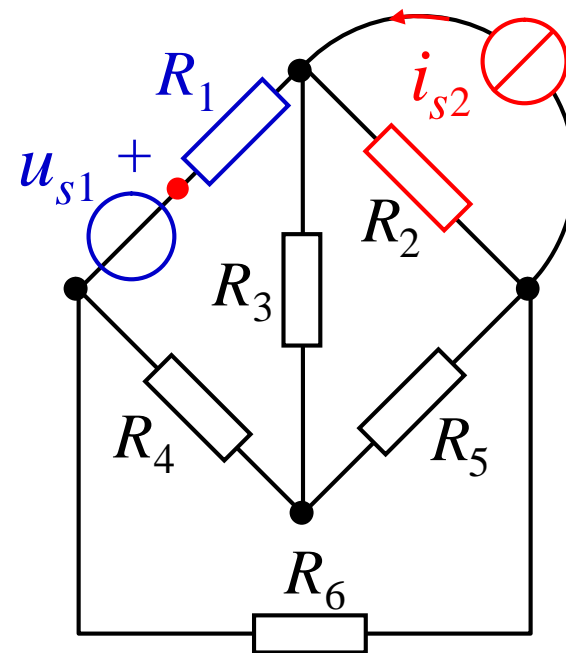

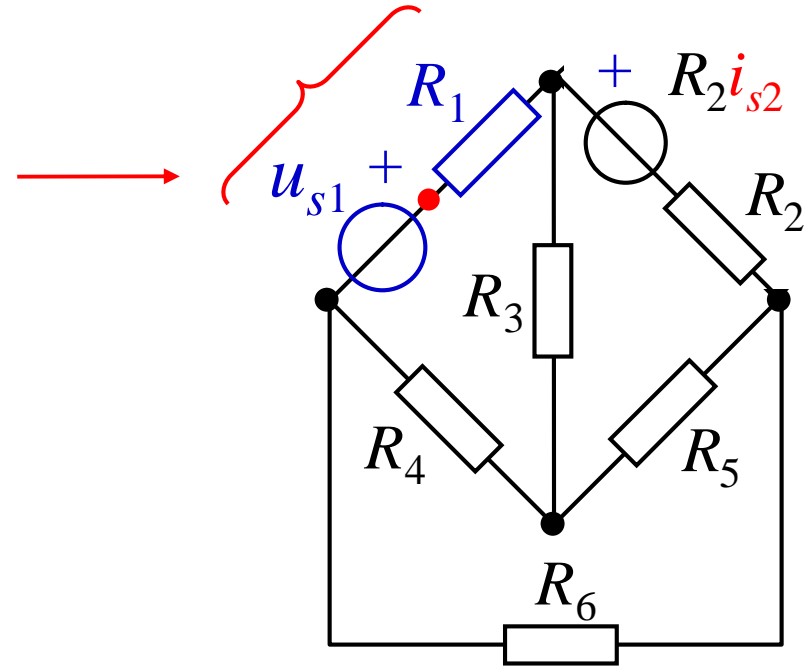
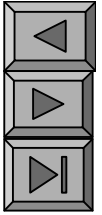

4

6

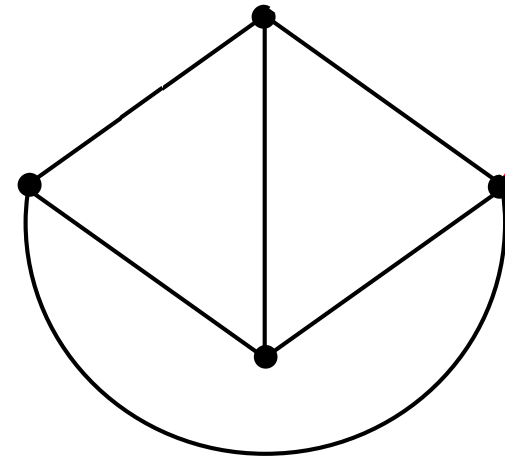

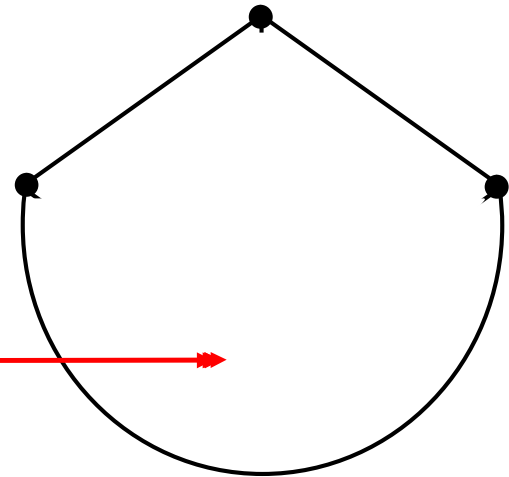
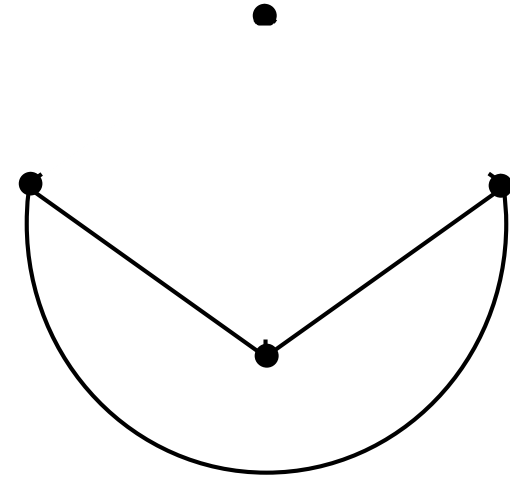
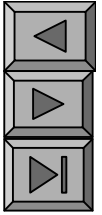

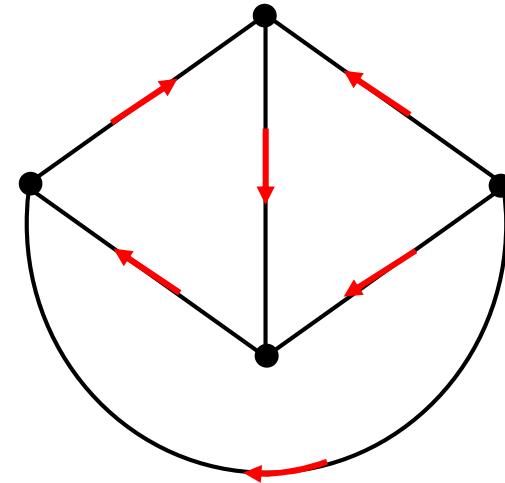
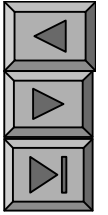

( )



- 
- 
-

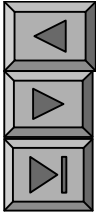

“ ”



# 3 2 KCL KVL

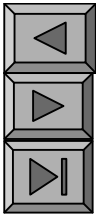

## KCL

- 

## LVL

$$\begin{array}{l}
 \cancel{i_1} + \underline{i_4} + \cancel{i_6} = 0 \\
 \cancel{i_1} + \cancel{i_2} + \underline{i_3} = 0 \\
 \cancel{i_2} + \underline{i_5} + \cancel{i_6} = 0 \\
 \underline{i_3} + \underline{i_4} + i_5 = 0
 \end{array}$$

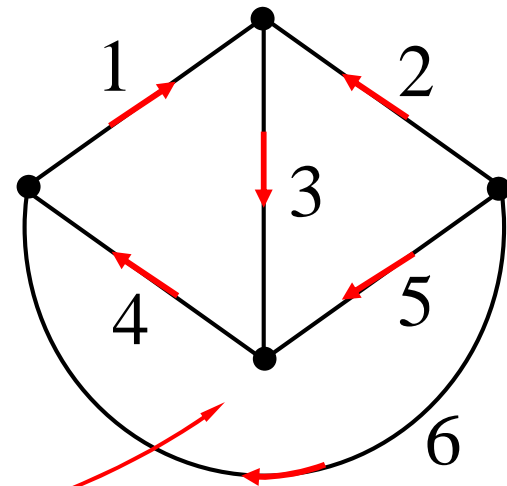

- 4

0

3

( )

( )



1.

( )



G

G

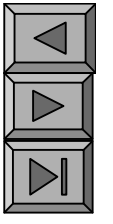
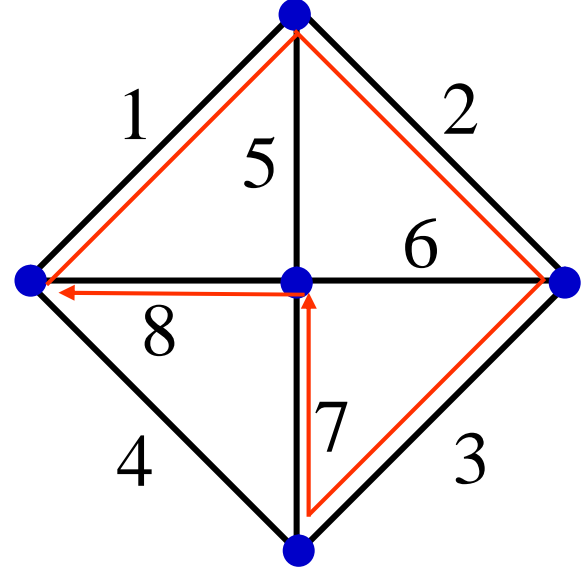
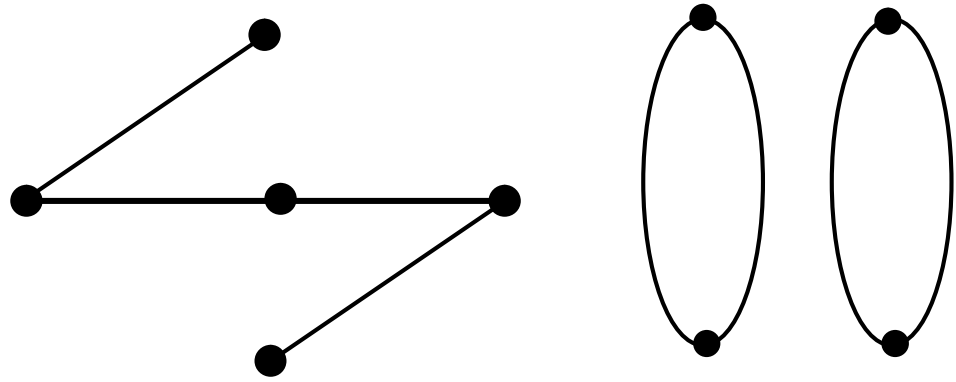

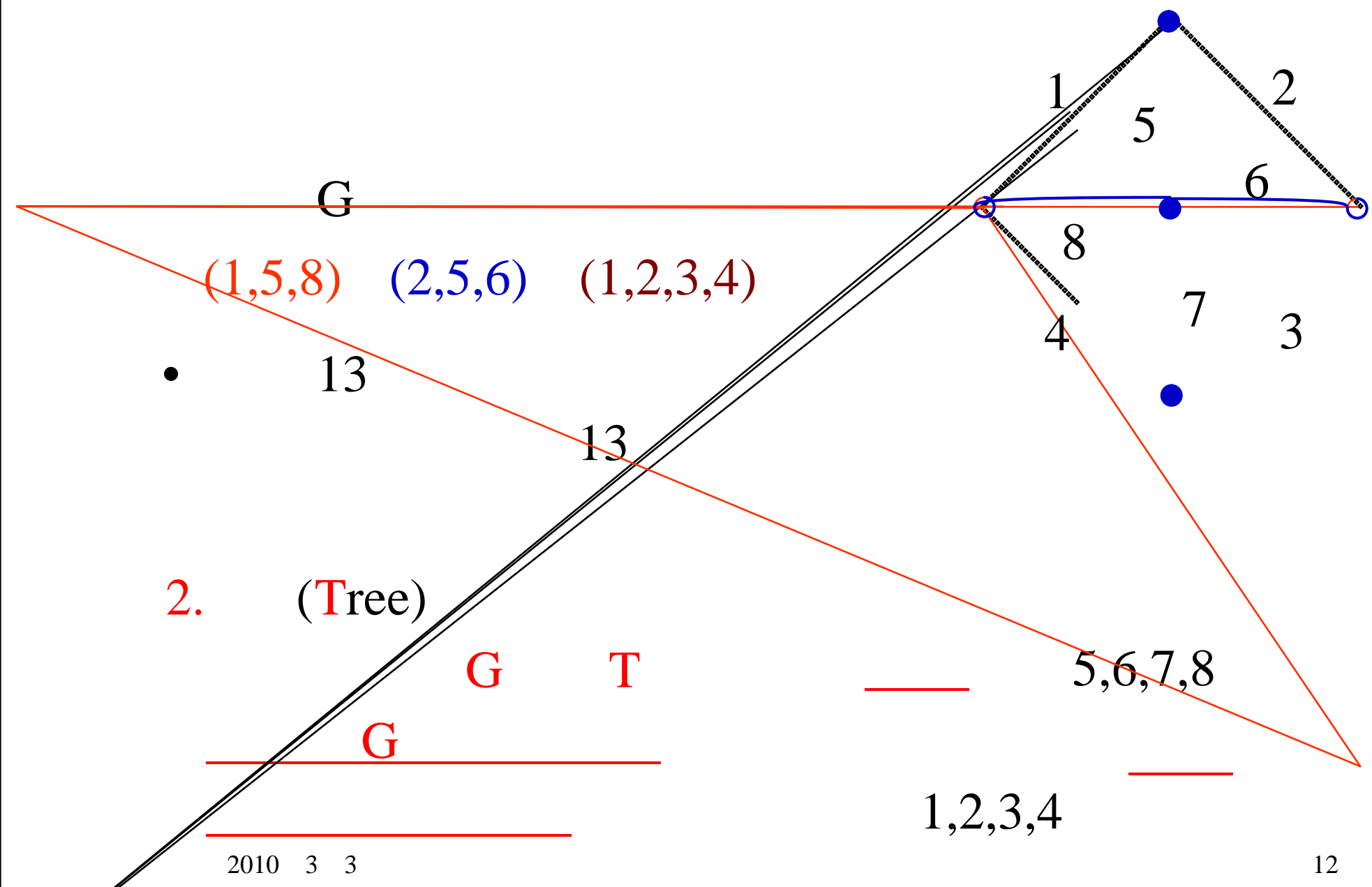
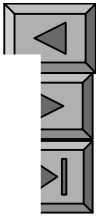

(1,5,8) (2,5,6) (1,2,3,4)

•

13

13

2. (Tree)

G

T

G

5,6,7,8

1,2,3,4

2010 3 3

12

(1,2,3,6,8)

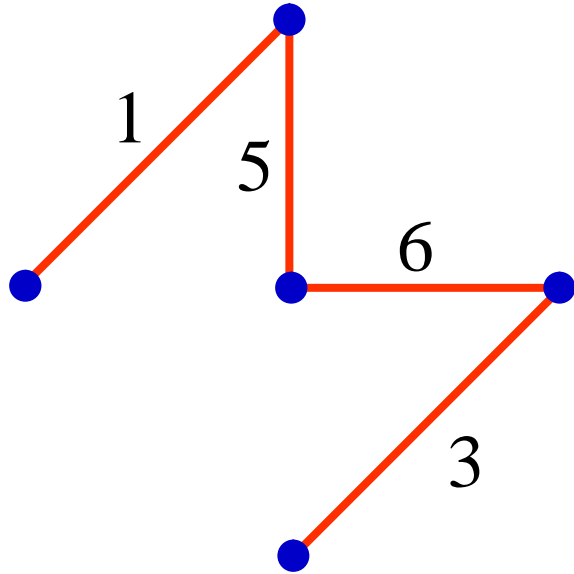
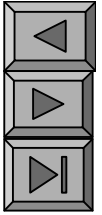

T

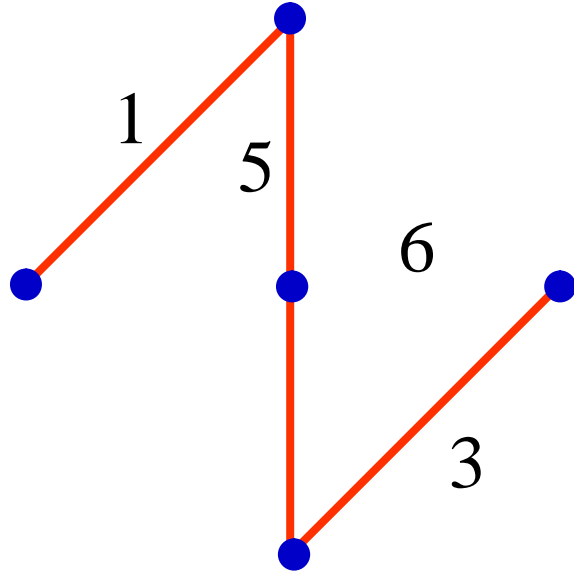
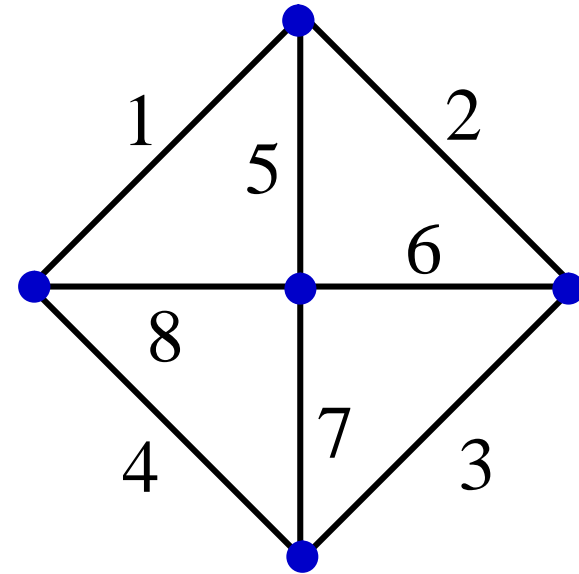

•

G 5  
T

4

•

$n$   
 $(n - 1)$

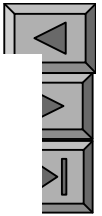

G  
 $n (=5)$

- 
- 

1

G  
2

(  
)

$n (=5)$

$(n - 1 = 4)$

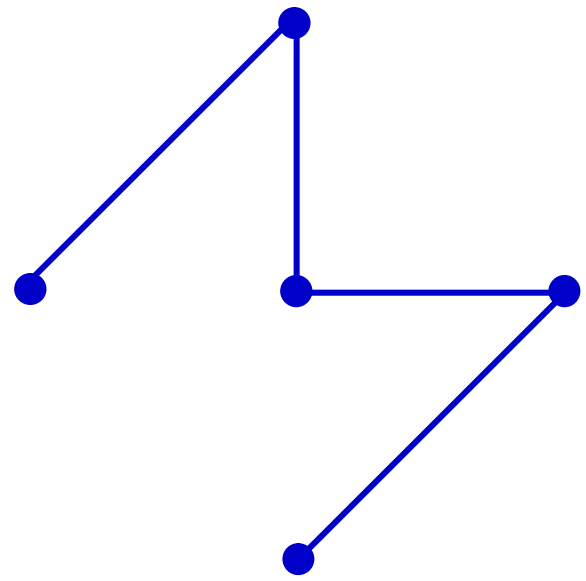

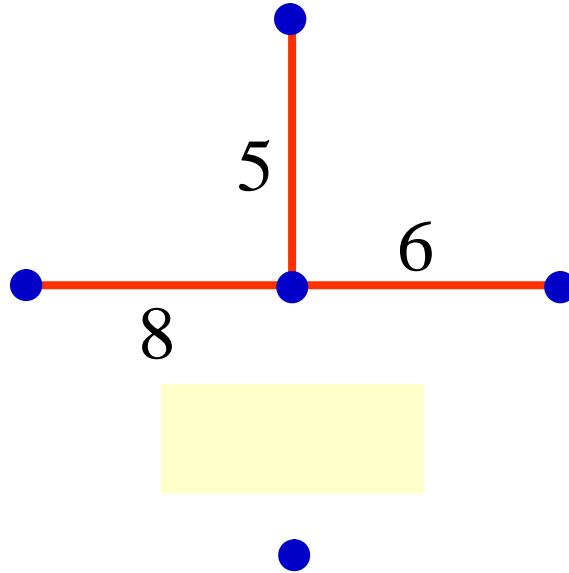
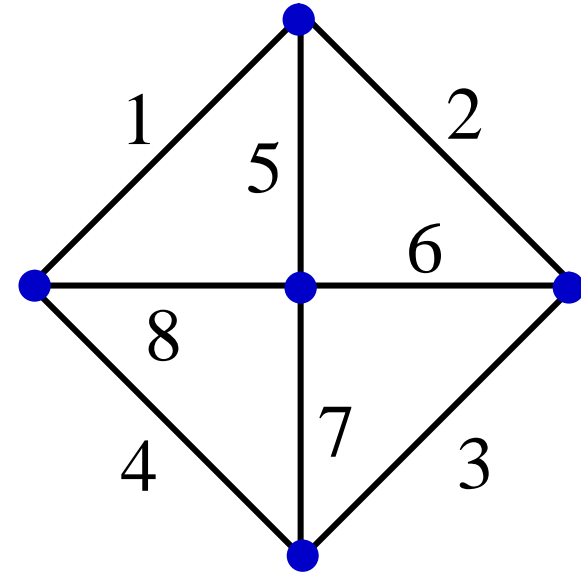
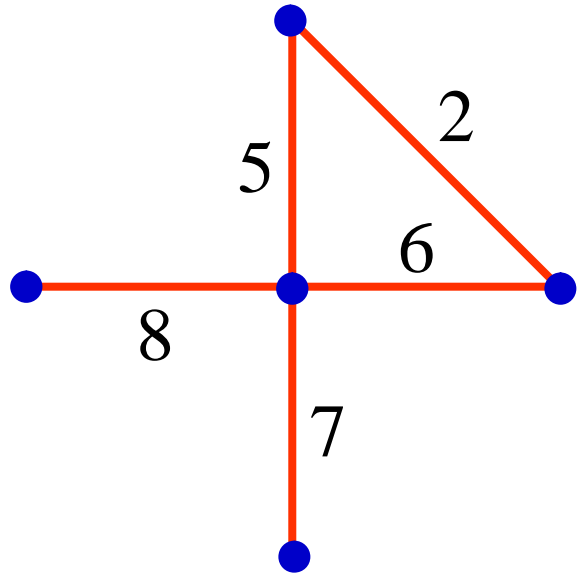
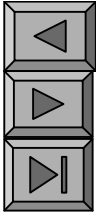

3.



)



(

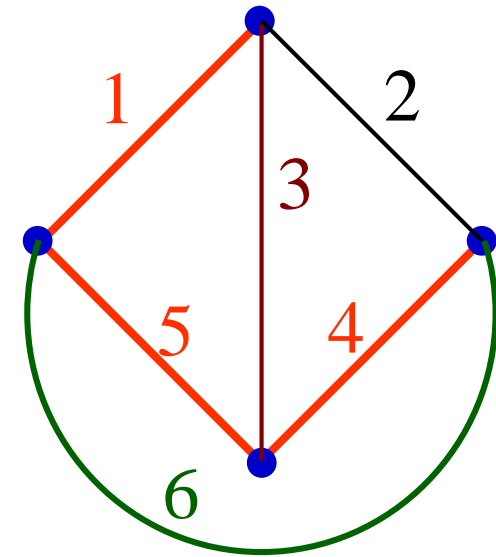
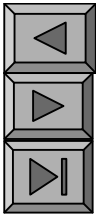
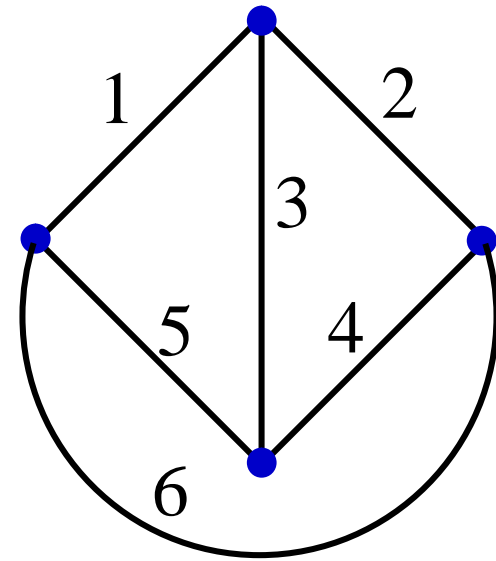



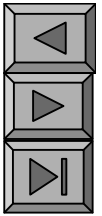

•



•

$G \quad n \quad b$   
 $G \quad (n-1)$

$b \quad (n-1)$

•

$l = b \quad (n-1)$

2

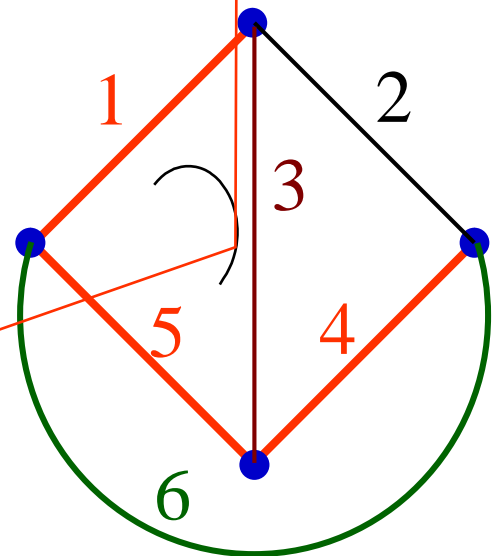

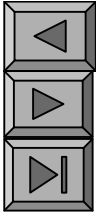

•

•

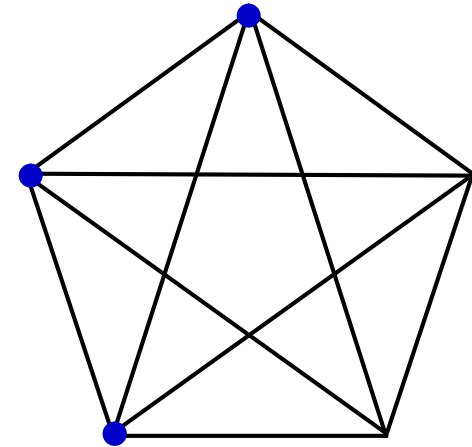
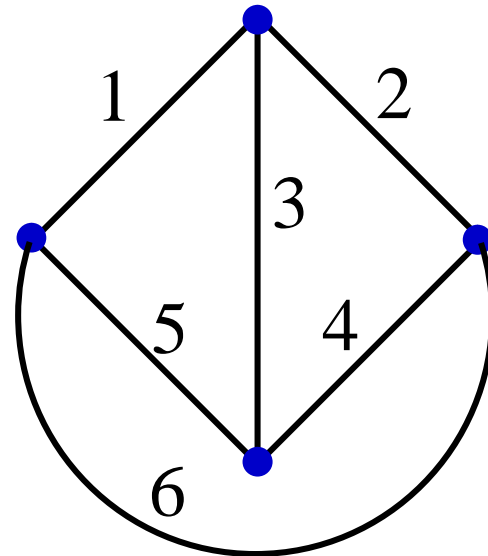

$$l = b - (n - 1)$$

➤ KVL

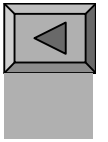

3 3

•

•

$b$  :

KCL:  $(n-1)$   
KVL:  $(b-n+1)$  }  $b$

VCR:  $b$

$n$

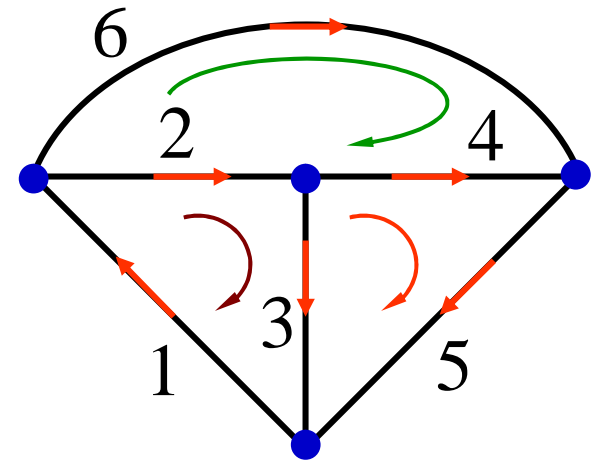

•

$2b$

•

$2b$

$2b$

$2b$

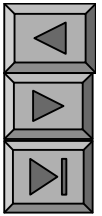

$2b$

$b$

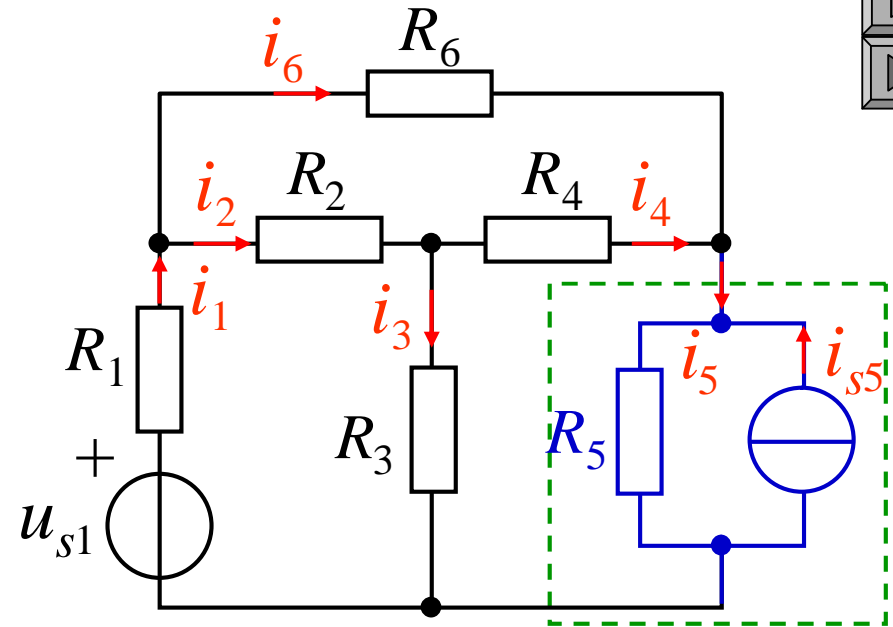

VAR

KCL KVL

1.  
(1)

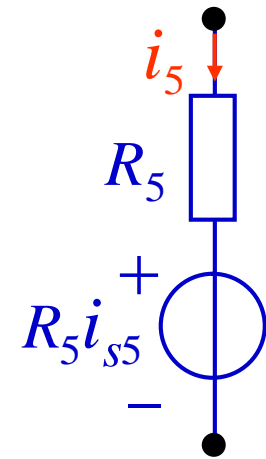

Knoten  $n = 1$ )

$$\begin{aligned} -i_1 + i_2 + i_3 &= 0 \\ -i_2 + i_4 &= 0 \\ -i_3 + i_5 &= 0 \end{aligned}$$

(3)

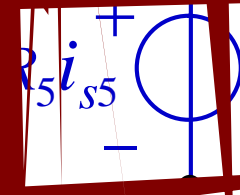
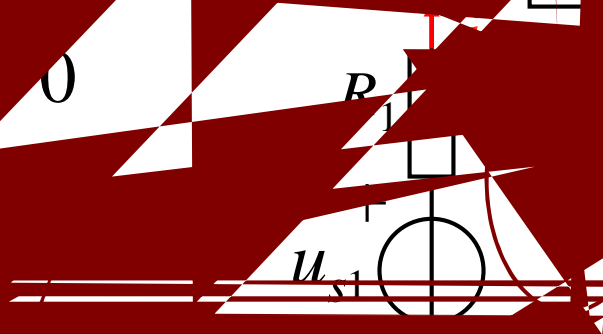

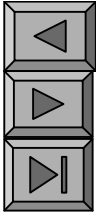

$$\begin{aligned}
 -i_1 + i_2 + i_6 &= 0 \\
 -i_2 + i_3 + i_4 &= 0 \\
 -i_4 + i_5 - i_6 &= 0 \\
 R_1 i_1 + R_2 i_2 + R_3 i_3 &= u_{s1} \\
 -R_3 i_3 + R_4 i_4 + R_5 i_5 &= -R_5 i_{s5} \\
 -R_2 i_2 - R_4 i_4 + R_6 i_6 &= 0
 \end{aligned}$$

(4)  $i_1$   $i_6$

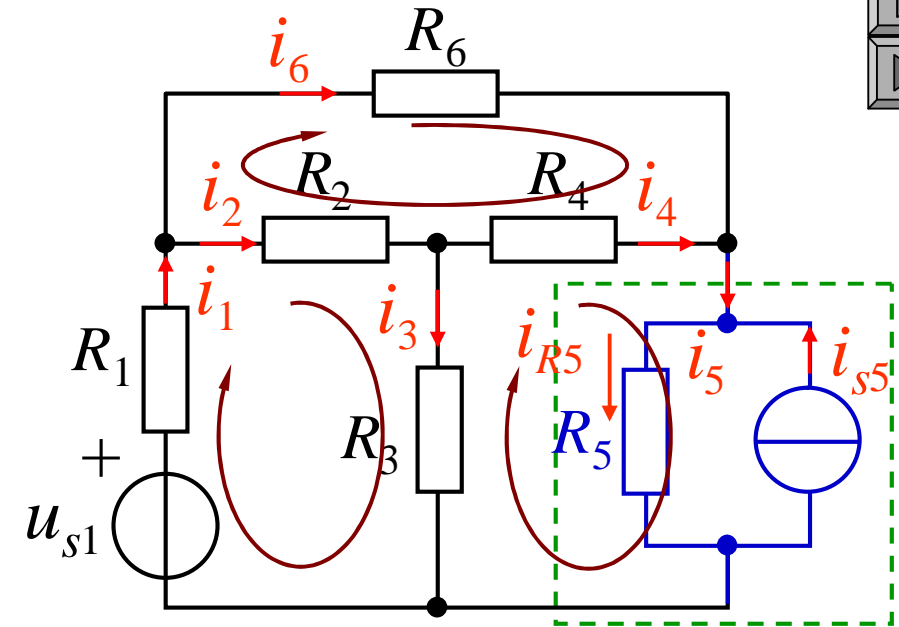

$R_5$

$$u_{14} = u_{s1} - R_1 i_1$$

$$i_{R5} = i_{s5} + i_5$$

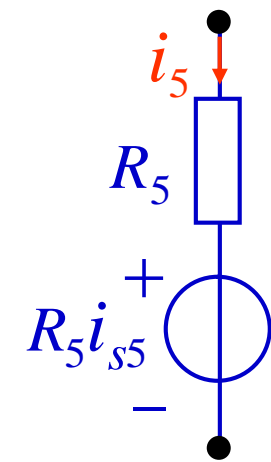

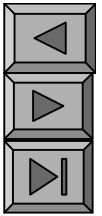

# KVL

$$\begin{aligned}
 R_1 i_1 + R_2 i_2 + R_3 i_3 &= u_{s1} \\
 -R_3 i_3 + R_4 i_4 + R_5 i_5 &= -R_5 i_{s5} \\
 -R_2 i_2 - R_4 i_4 + R_6 i_6 &= 0
 \end{aligned}$$

$$R_k i_k = u_{sk}$$

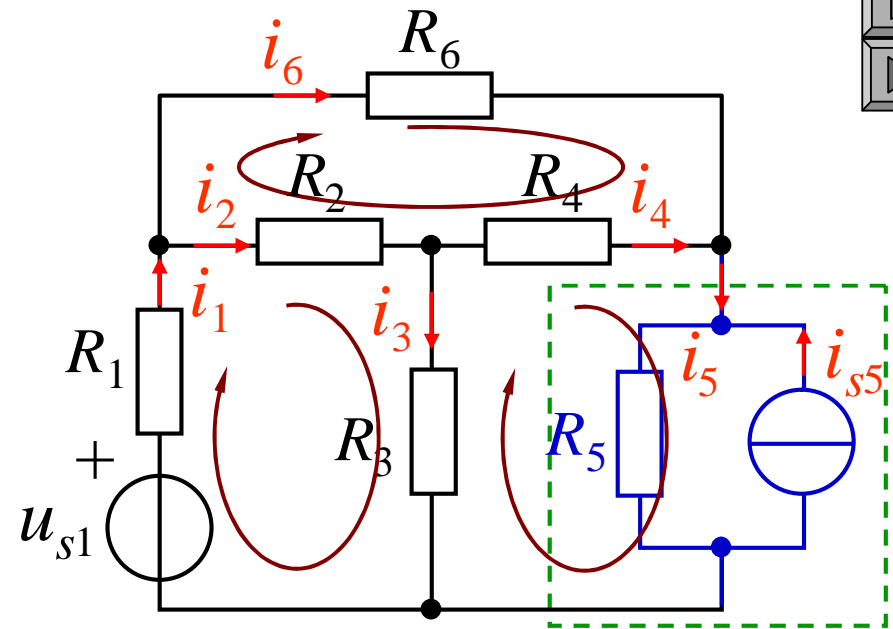

- $i_k$

- 

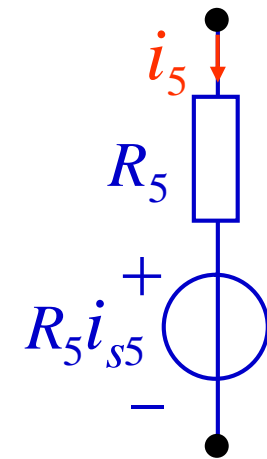
 $u_{sk}$ 
 $R_k i_k$ 
 $u_{sk}$ 



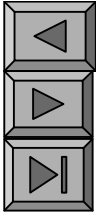

3 4



KVL

KCL

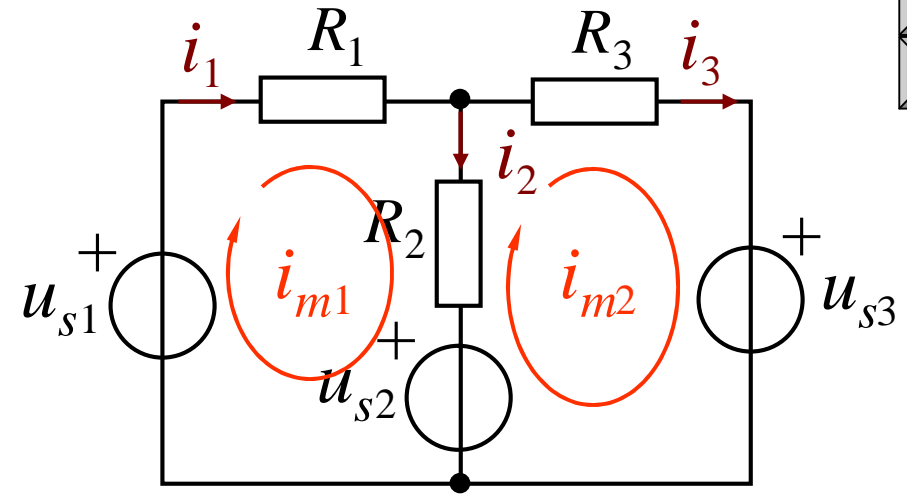
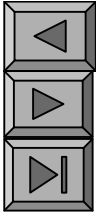

KVL

1.

(1)

(2)

KVL

$$i_{m1} \quad i_{m2} \quad R_2$$

$$1 \quad R_1 i_{m1} + R_2 i_{m1} - R_2 i_{m2} = u_{s1} - u_{s2}$$

$$2 \quad R_2 i_{m1} + R_2 i_{m2} + R_3 i_{m2} = u_{s2} - u_{s3}$$

$$R_{11}i_{m1} + R_{12}i_{m2} = u_{s11}$$

$$R_{21}i_{m1} + R_{22}i_{m2} = u_{s22}$$

$$R_{11}i_{m1} \quad i_{m1} \quad 1$$

$$R_{22}i_{m2} \quad i_{m2} \quad 2$$

$$R_{11} = R_1 + R_2$$

$$R_{22} = R_2 + R_3$$

---

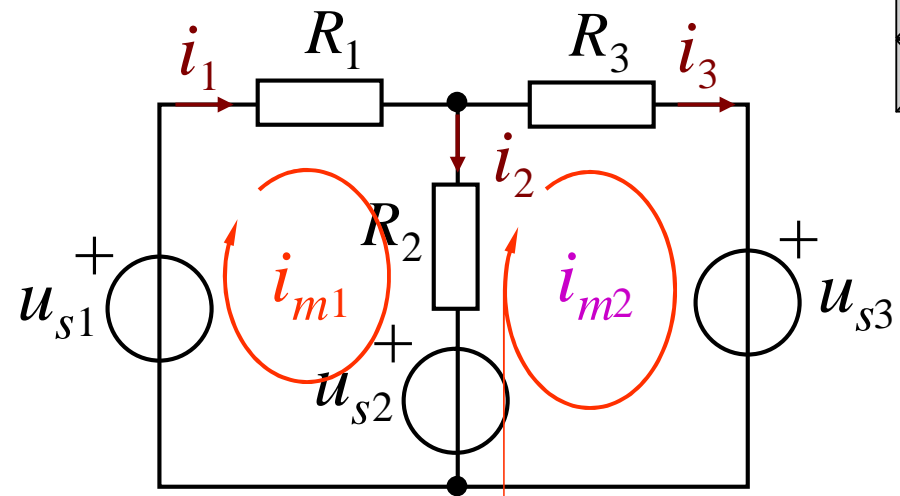

$$R_1 i_{m1} + R_2 i_{m1} - R_2 i_{m2} = u_{s1} - u_{s2}$$

$$R_2 i_{m1} + R_2 i_{m2} + R_3 i_{m2} = u_{s2} - u_{s3}$$

$$(R_1 + R_2) i_{m1} - R_2 i_{m2} = u_{s1} - u_{s2}$$

$$R_2 i_{m1} + (R_2 + R_3) i_{m2} = u_{s2} - u_{s3}$$

---

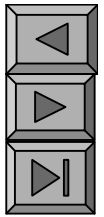

$$R_{11}i_{m1} + R_{12}i_{m2} = u_{s11}$$

$$R_{21}i_{m1} + R_{22}i_{m2} = u_{s22}$$

$$R_{12}i_{m2} \quad i_{m2} \quad 1$$

$$R_{21}i_{m1} \quad i_{m1} \quad 2$$

$$R_{12} \quad R_{21}$$

$$i_{m2} \quad (i_{m1})$$

$$R_{12} = R_{21} = R_2$$

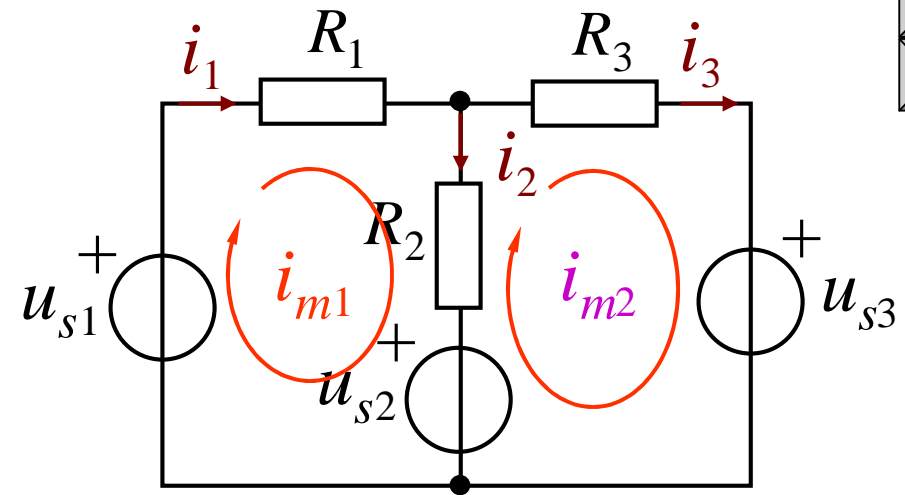

1 (2)

$$(R_1 + R_2)i_{m1} - R_2i_{m2} = u_{s1} - u_{s2}$$

$$R_2i_{m1} + (R_2 + R_3)i_{m2} = u_{s2} - u_{s3}$$

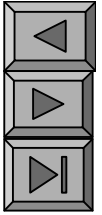

2.  $m$

$$R_{11}i_{m1} + R_{12}i_{m2} + R_{13}i_{m3} + \dots + R_{1m}i_{mm} = u_{s11}$$

$$R_{21}i_{m1} + R_{22}i_{m2} + R_{23}i_{m3} + \dots + R_{2m}i_{mm} = u_{s22}$$

$$R_{31}i_{m1} + R_{32}i_{m2} + R_{33}i_{m3} + \dots + R_{3m}i_{mm} = u_{s33}$$

.....

$$R_{m1}i_{m1} + R_{m2}i_{m2} + R_{m3}i_{m3} + \dots + R_{mm}i_{mm} = u_{smm}$$

- $R_{11}$   $R_{mm}$  \_\_\_\_\_
- $R_{12}$   $R_{1m}$   $R_{21}$   $R_{m1}$

(1)

“ ”

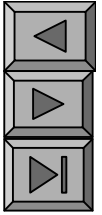

(2)

(3)

0

(4)

$$R_{ik} = R_{ki}$$

- $u_{s11}$   $u_{smm}$  1  $m$

“+”

“ ”

3-1 ( P60)

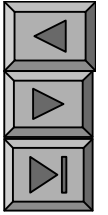

1.  $(T)$

$G$

(1)

(2)  $G$

(3)

1

2.  $(L)$

$G$

(1)

(2) 2

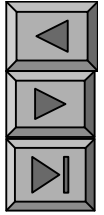

3. *KCL*

$$n-1$$

*KVL*

$$b - (n - 1)$$

4.

5.



P76 3 11( P77)

$U_0$

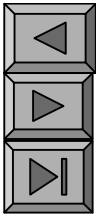

$$R_{11}=50\Omega$$

$$R_{22}=50\Omega$$

$$R_{33}=18\Omega$$

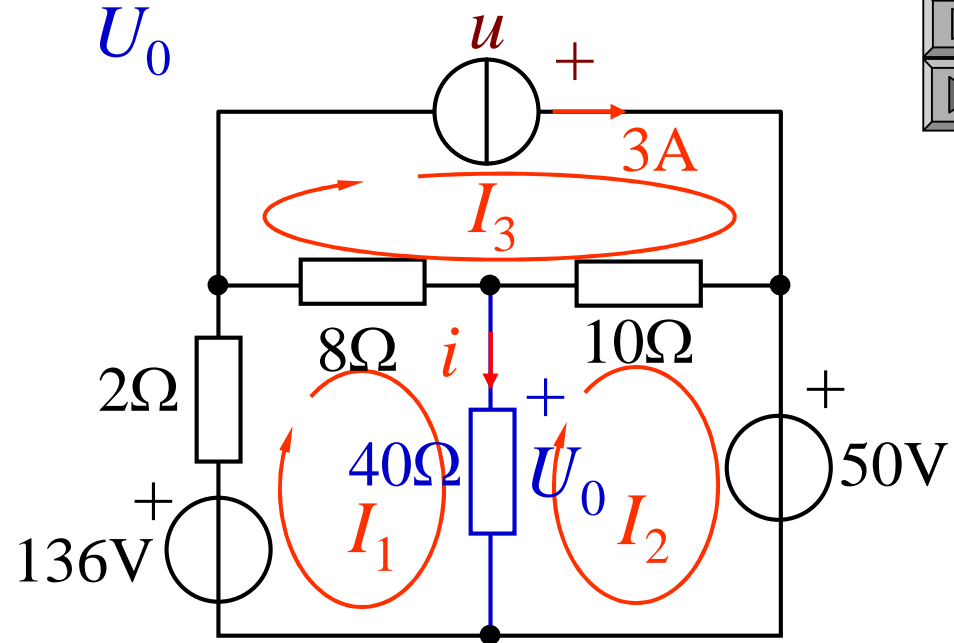
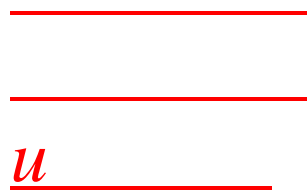

$$R_{12}=R_{21}= 40\Omega$$

$$R_{13}=R_{31}= 8\Omega$$

$$R_{23}=R_{32}= 10\Omega$$

$$\begin{cases} 50 I_1 - 40 I_2 - 8 I_3 = 136 \\ -40 I_1 + 50 I_2 - 10 I_3 = -50 \\ -8 I_1 - 10 I_2 + 18 I_3 = u \end{cases}$$

$I_3=3A$

$$I_1=8A \quad I_2=6A$$

$$\underline{\underline{U_0=40i=40(I_1 - I_2) =80V}}$$



3-5

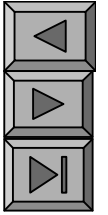

KVL



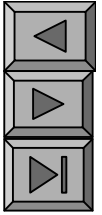

$i_1 \quad i_2 \quad i_3$

$i_{l1} \quad i_{l2} \quad i_{l3}$

$i_1 = i_{l1} \quad i_2 = i_{l2} \quad i_3 = i_{l3}$

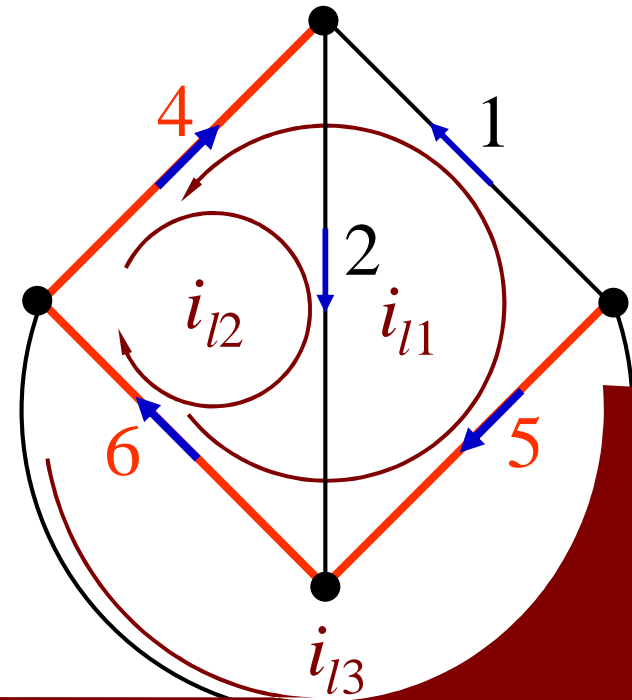

$$i_4 = -i_{l1} + i_{l2}$$

$$i_5 = -i_{l1} - i_{l3}$$

$$i_6 = -i_{l1} + i_{l2} - i_{l3}$$

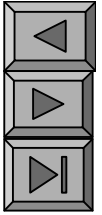

KCL

$$i_4 = -i_1 + i_2 = -i_{l1} + i_{l2}$$

$$i_5 = -i_1 - i_3 = -i_{l1} - i_{l3}$$

$$i_6 = -i_1 + i_2 - i_3 = -i_{l1} + i_{l2} - i_{l3}$$

- 
- 

KCL

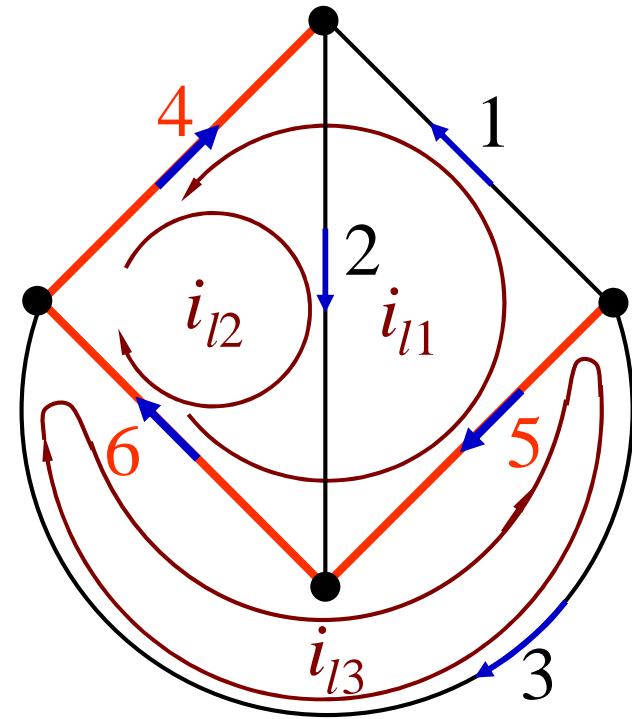

“ ”

( )

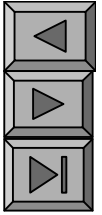

1.

- $b$   $n$   $( \quad )$   
 $l = b$   $(n - 1)$  KVL

$$R_{11}i_{l1} + R_{12}i_{l2} + R_{13}i_{l3} + \dots + R_{1l}i_{ll} = u_{s11}$$

$$R_{21}i_{l1} + R_{22}i_{l2} + R_{23}i_{l3} + \dots + R_{2l}i_{ll} = u_{s22}$$

$$R_{31}i_{l1} + R_{32}i_{l2} + R_{33}i_{l3} + \dots + R_{3l}i_{ll} = u_{s33}$$

.....

$$R_{l1}i_{l1} + R_{l2}i_{l2} + R_{l3}i_{l3} + \dots + R_{ll}i_{ll} = u_{sll}$$

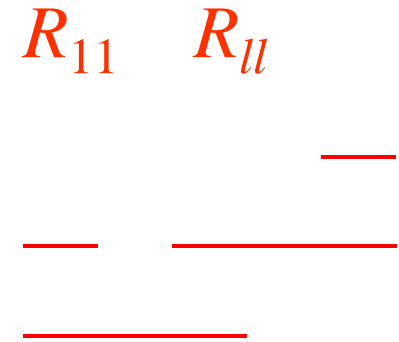

$$R_{12} \quad R_{13} \quad R_{23} \quad R_{l1} \quad R_{l2}$$



“ ”

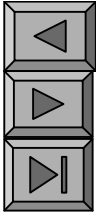

$$\begin{bmatrix} R_{11} & R_{12} & R_{13} & \cdots & R_{1l} \\ R_{21} & R_{22} & R_{23} & \cdots & R_{2l} \\ R_{31} & R_{32} & R_{33} & \cdots & R_{3l} \\ \cdots & \cdots & \cdots & \cdots & \cdots \\ R_{l1} & R_{l2} & R_{l3} & \cdots & R_{ll} \end{bmatrix} \begin{bmatrix} i_{l1} \\ i_{l2} \\ i_{l3} \\ \vdots \\ i_{li} \end{bmatrix} = \begin{bmatrix} u_{s11} \\ u_{s22} \\ u_{s33} \\ \vdots \\ u_{sll} \end{bmatrix}$$

$$u_{s11} \quad u_{sll} \quad \quad \quad 1 \quad l \quad \quad \quad 0$$

2.

P65 3 2

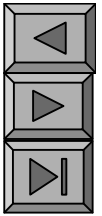
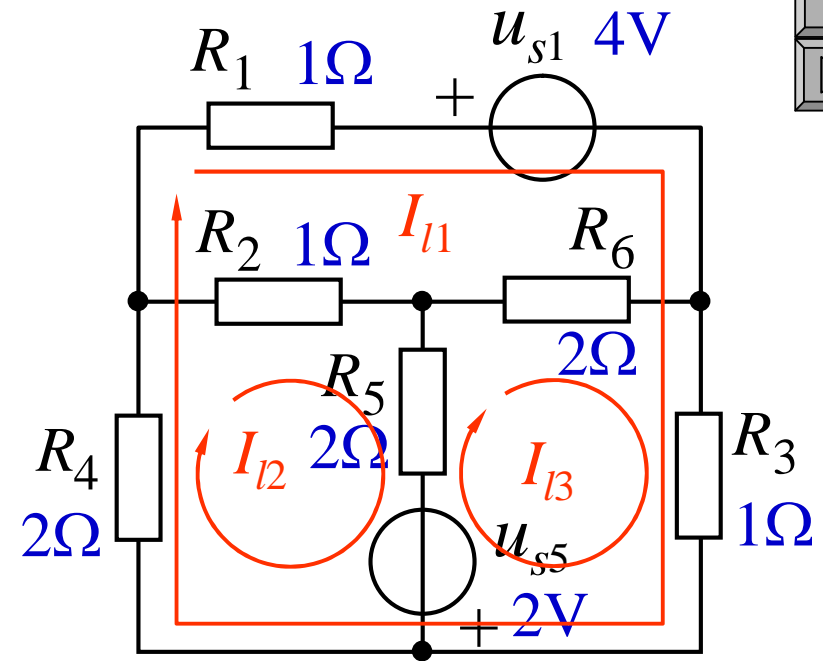

$$\left. \begin{aligned}
 \text{L1} \quad & 4I_{l1} + 2I_{l2} + 1I_{l3} = -4 \\
 \text{L2} \quad & 2I_{l1} + 5I_{l2} - 2I_{l3} = 2 \\
 \text{L3} \quad & 1I_{l1} - 2I_{l2} + 5I_{l3} = -2
 \end{aligned} \right\}$$



2.

P65

3 2

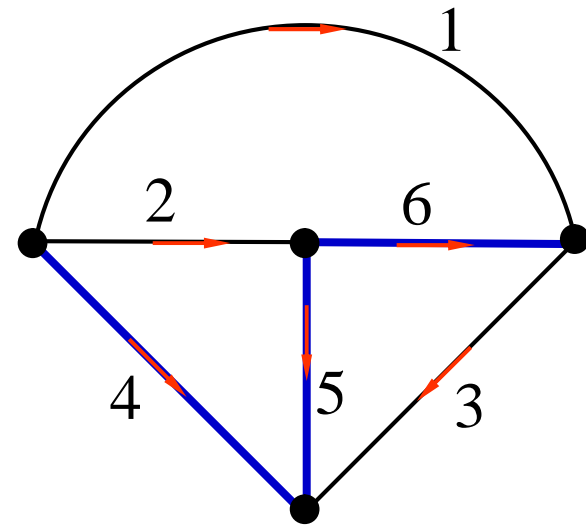
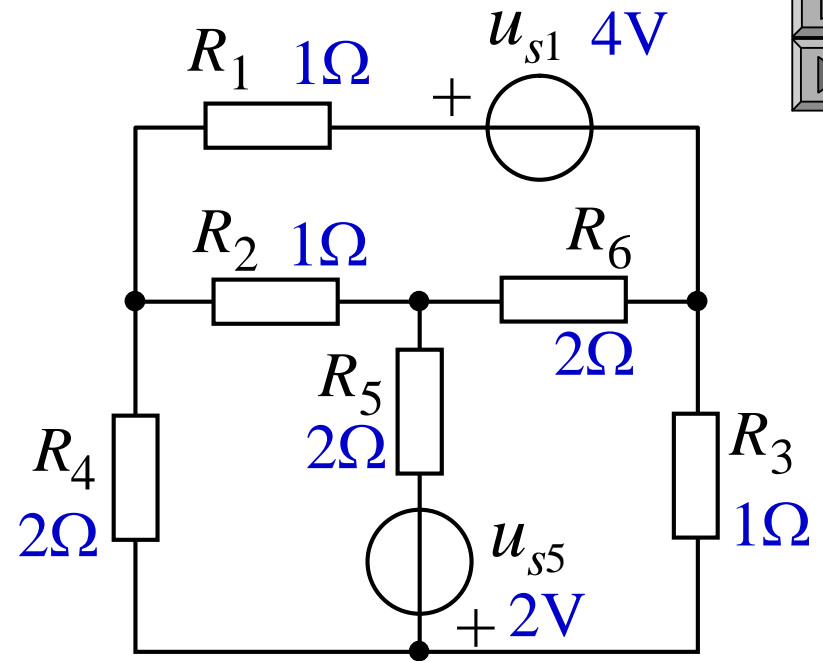
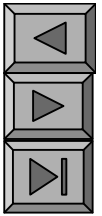

P67 3 3

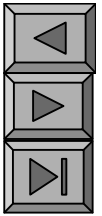

(1)

(2)

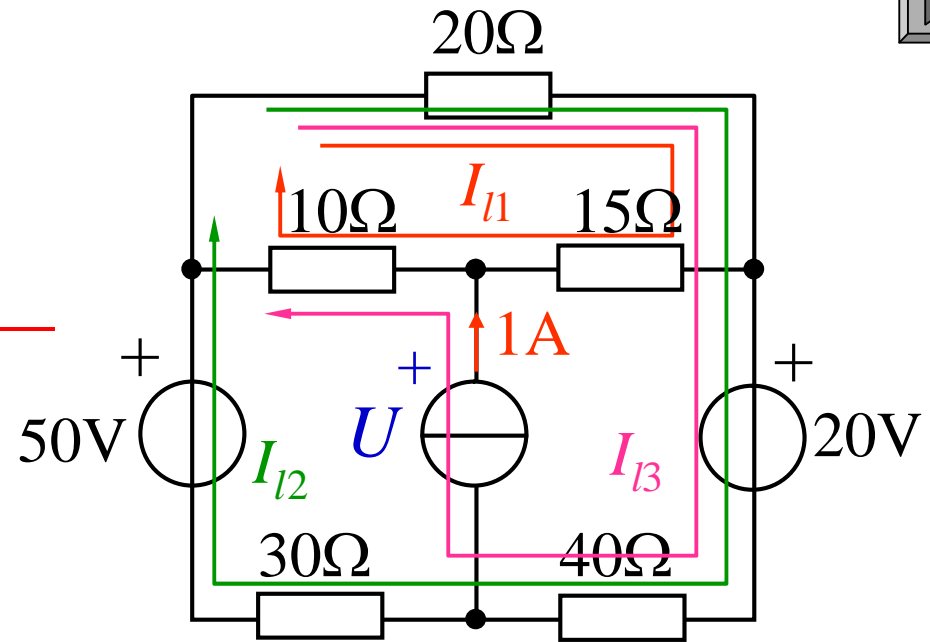

$$45I_{l1} + 20I_{l2} + 30I_{l3} = 0$$

$$20I_{l1} + 90I_{l2} + 60I_{l3} = 30$$

$$30I_{l1} + 60I_{l2} + 70I_{l3} = U - 20$$

$$I_{l3} = 1$$

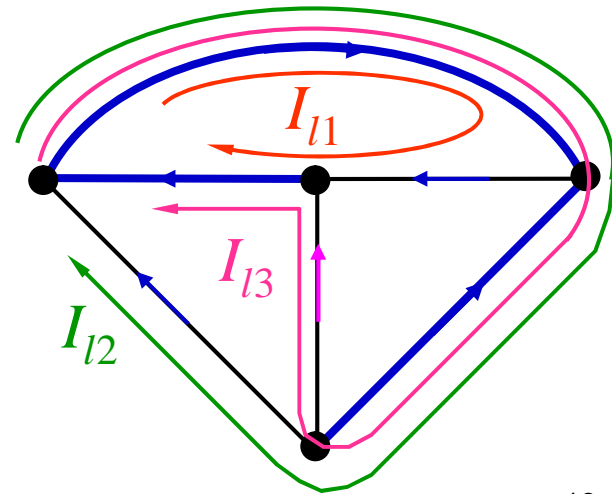

P67-68 3 4

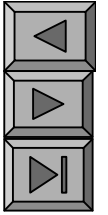

---

---

---

---

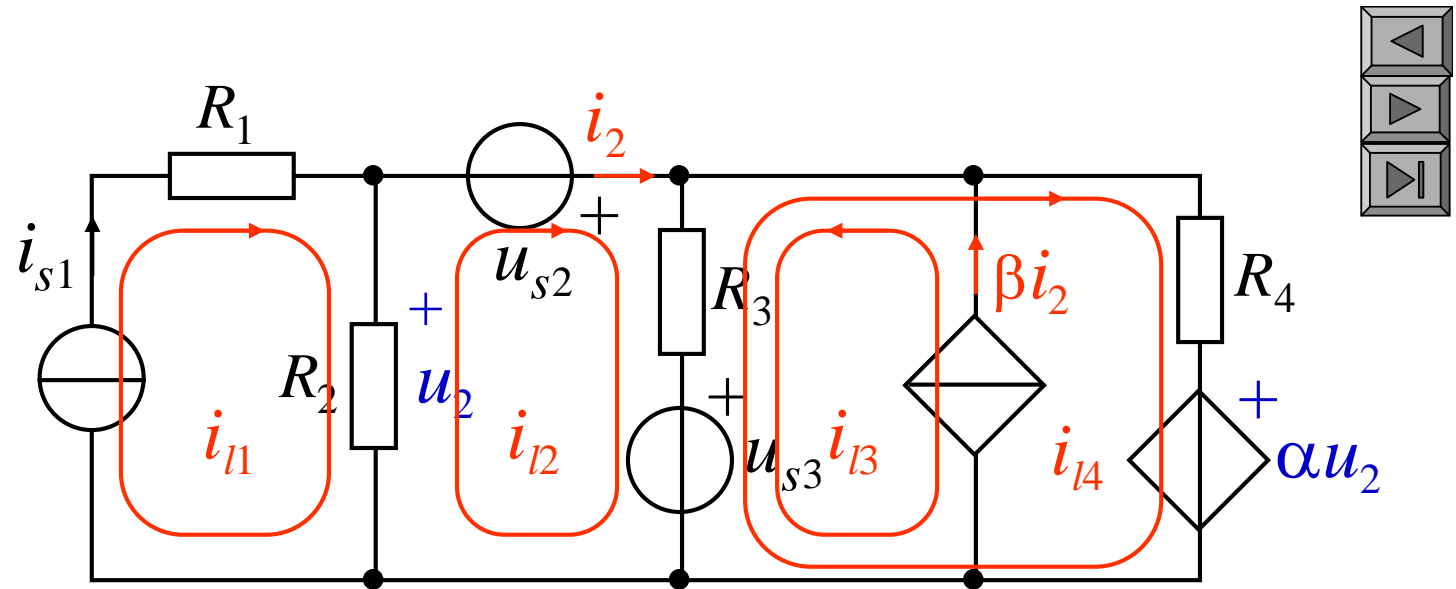

$$\text{L2} \quad \underline{-R_2 i_{l1} + (R_2 + R_3) i_{l2} + R_3 i_{l3} - R_3 i_{l4} = u_{s2} - u_{s3}}$$

$$\text{L4} \quad -R_3 i_{l2} - R_3 i_{l3} + (R_3 + R_4) i_{l4} = u_{s3} - \alpha u_2$$

1 3  
KVL

$$\underline{i_{l1} = i_{s1}} \quad \underline{i_{l3} = \beta i_{l2}}$$

$$\alpha u_2 = \alpha R_2 (i_{l1} - i_{l2}) = \alpha R_2 i_{l1} - \alpha R_2 i_{l2}$$

$$\underline{\alpha R_2 i_{l1} - (\alpha R_2 + R_3) i_{l2} - R_3 i_{l3} + (R_3 + R_4) i_{l4} = u_{s3}}$$

3 6

•

•

•

$n$   
)

$(n - 1)$

(

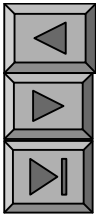
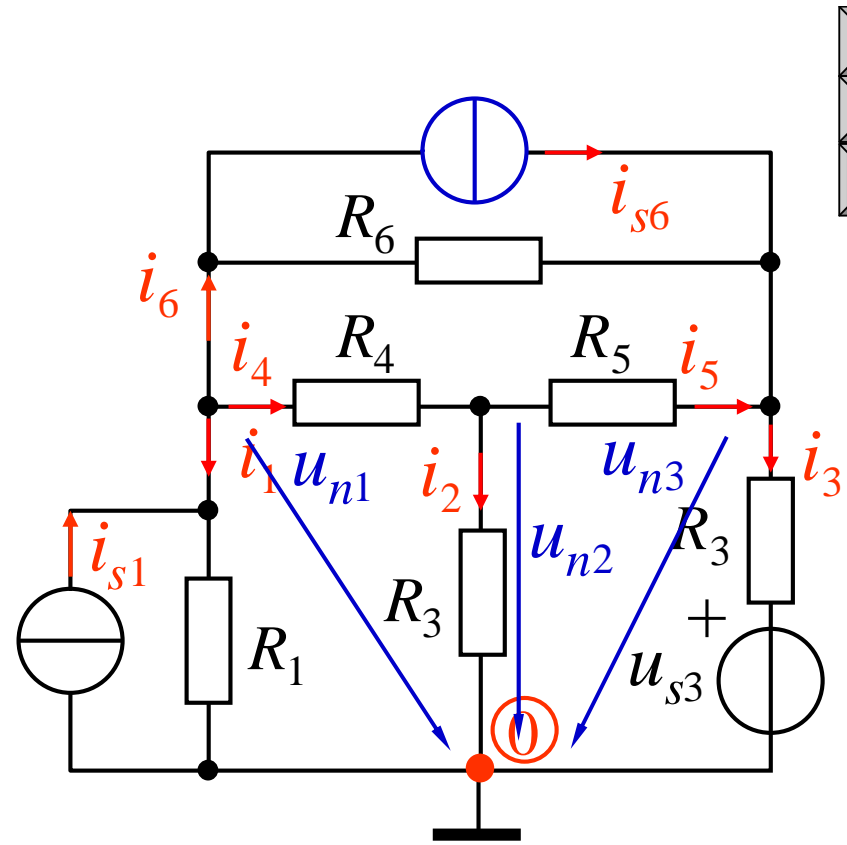



1.

•

•  $u_{n1} = u_1 \quad u_{n2} = u_2 \quad u_{n3} = u_3$

•

KVL  $u_1 + u_4 + u_2 = 0$

$u_4 = u_1 \quad u_2 = u_{n1} \quad u_{n2}$

$u_5 = u_{n2} \quad u_{n3}$

$u_6 = u_{n1} \quad u_{n3}$

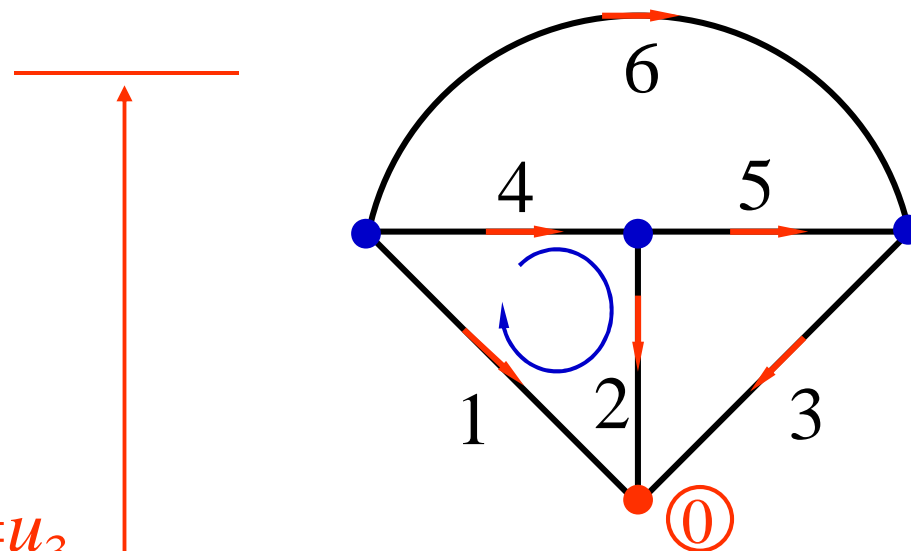

$u_1 \quad u_6$   
 $u_{n1} \quad u_{n3}$

2.

KCL !

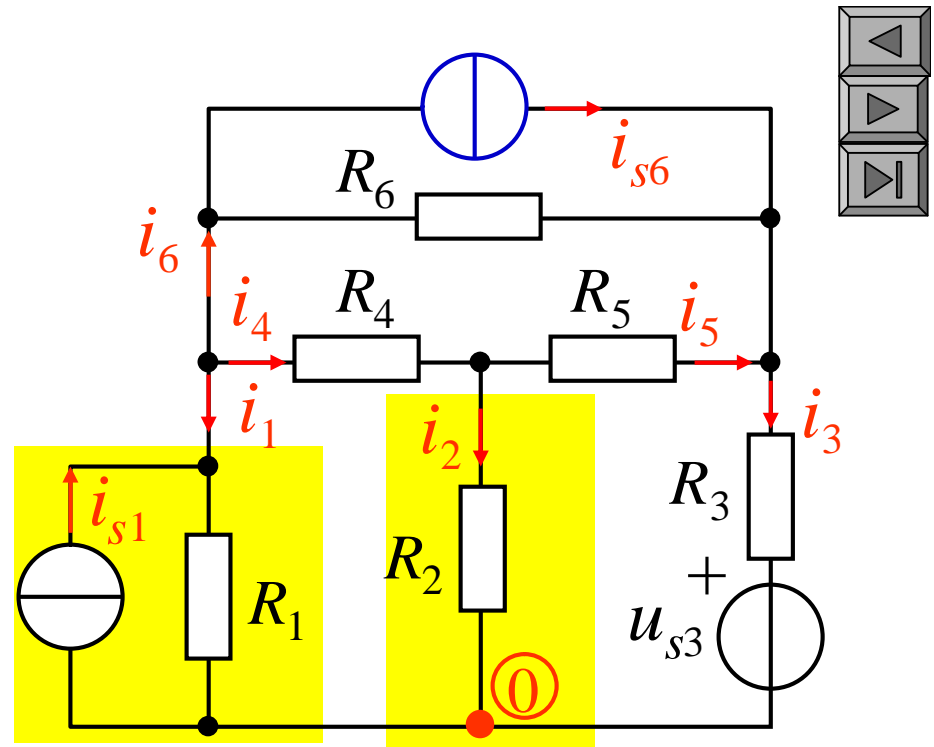

$$i_1 = \frac{u_{n1}}{R_1} - i_{s1}$$

$$i_2 = \frac{u_{n2}}{R_2}$$

$$i_3 = \frac{u_{n3} - u_{s3}}{R_3}$$

$$i_4 = \frac{u_{n1} - u_{n2}}{R_4}$$

$$i_5 = \frac{u_{n2} - u_{n3}}{R_5}$$

$$i_6 = \frac{u_{n1} - u_{n3}}{R_6} + i_{s6}$$

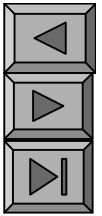

KCL:

$$i_s \begin{cases} i_1 + i_4 + i_6 = 0 \\ i_2 \quad i_4 + i_5 = 0 \\ i_3 \quad i_5 \quad i_6 = 0 \end{cases}$$

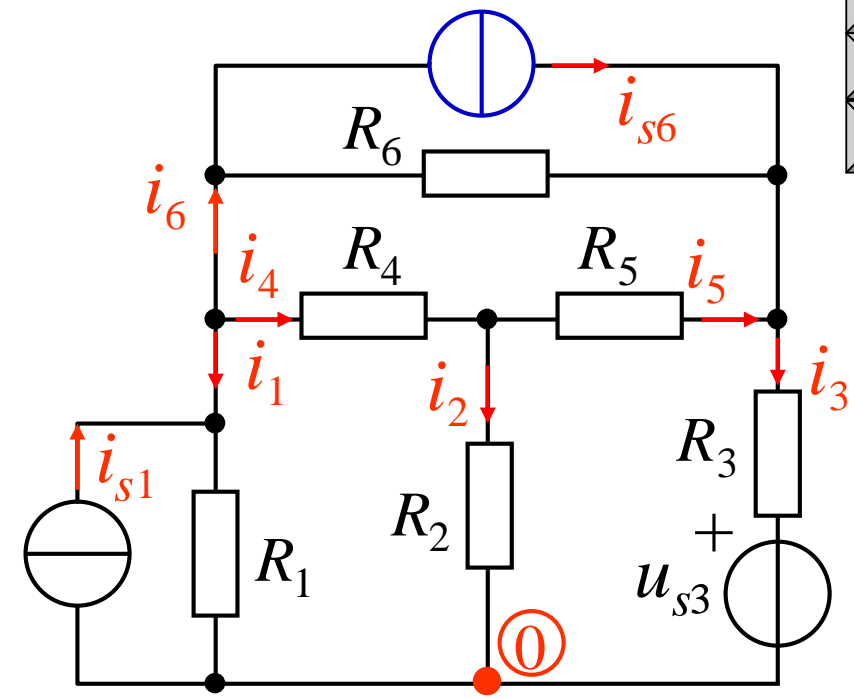



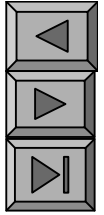

$$\left[ \frac{1}{R_1} + \frac{1}{R_4} + \frac{1}{R_6} \right] u_{n1} - \frac{1}{R_4} u_{n2} - \frac{1}{R_6} u_{n3} = i_{s1} - i_{s6}$$

$$- \frac{1}{R_4} u_{n1} + \left[ \frac{1}{R_2} + \frac{1}{R_4} + \frac{1}{R_5} \right] u_{n2} - \frac{1}{R_6} u_{n3} = 0$$

$$- \frac{1}{R_6} u_{n1} - \frac{1}{R_5} u_{n2} + \left[ \frac{1}{R_3} + \frac{1}{R_5} + \frac{1}{R_6} \right] u_{n3} = i_{s6} + \frac{u_{s3}}{R_3}$$

$$\frac{1}{R_1} \quad \frac{1}{R_6} \quad G_1 \quad G_6$$

$$(G_1 + G_4 + G_6)u_{n1} \quad G_4 u_{n2} \quad G_6 u_{n3} = i_{s1} \quad i_{s6}$$

$$G_4 u_{n1} + (G_2 + G_4 + G_5)u_{n2} \quad G_5 u_{n3} = 0$$

$$G_6 u_{n1} \quad G_5 u_{n2} + (G_3 + G_5 + G_6)u_{n3} = i_{s6} + G_3 u_{s3}$$

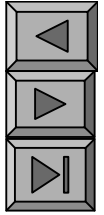

$$\begin{aligned}(G_1+G_4+G_6)u_{n1} \quad G_4u_{n2} \quad G_6u_{n3} &= i_{s1} \quad i_{s6} \\ G_4u_{n1}+(G_2+G_4+G_5)u_{n2} \quad G_5u_{n3} &= 0 \\ G_6u_{n1} \quad G_5u_{n2}+(G_3+G_5+G_6)u_{n3} &= i_{s6}+G_3u_{s3}\end{aligned}$$

$$\begin{aligned}G_{11}u_{n1}+G_{12}u_{n2}+G_{13}u_{n3} &= i_{s11} \\ G_{21}u_{n1}+G_{22}u_{n2}+G_{23}u_{n3} &= i_{s22} \\ G_{31}u_{n1}+G_{32}u_{n2}+G_{33}u_{n3} &= i_{s33}\end{aligned}$$

3.

- $G_{11} = (G_1+G_4+G_6)$

$$G_{22} = (G_2+G_4+G_5)$$

$$G_{33} = (G_3+G_5+G_6)$$

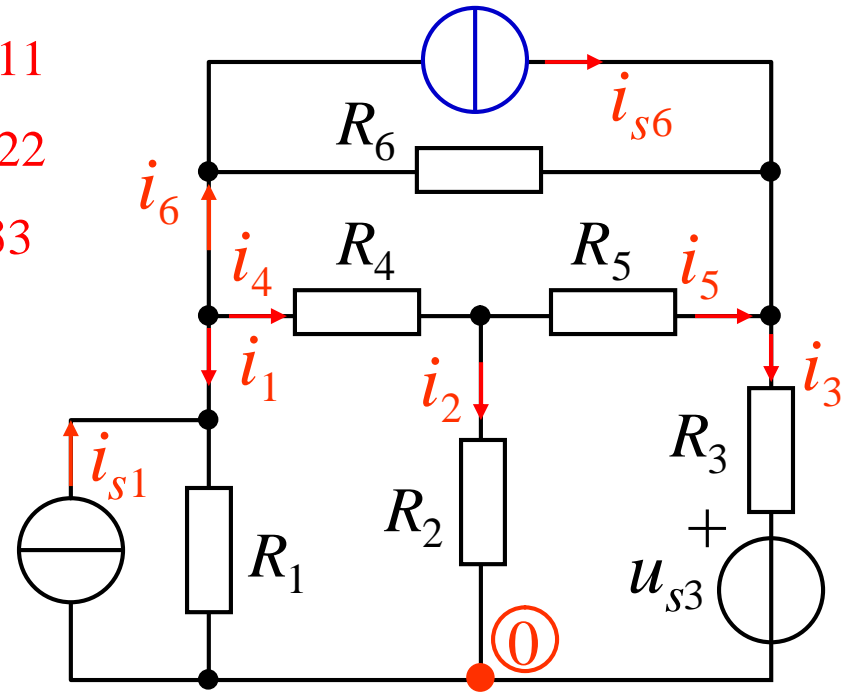

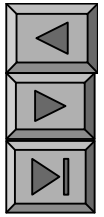

$$\begin{aligned}(G_1+G_4+G_6)u_{n1} \quad G_4u_{n2} \quad G_6u_{n3} &= i_{s1} \quad i_{s6} \\ G_4u_{n1}+(G_2+G_4+G_5)u_{n2} \quad G_5u_{n3} &= 0 \\ G_6u_{n1} \quad G_5u_{n2}+(G_3+G_5+G_6)u_{n3} &= i_{s6}+G_3u_{s3}\end{aligned}$$

$$\begin{aligned}G_{11}u_{n1}+G_{12}u_{n2}+G_{13}u_{n3} &= i_{s11} \\ G_{21}u_{n1}+G_{22}u_{n2}+G_{23}u_{n3} &= i_{s22} \\ G_{31}u_{n1}+G_{32}u_{n2}+G_{33}u_{n3} &= i_{s33}\end{aligned}$$

$$\begin{aligned}G_{12} &= G_{21} = -G_4 \\ G_{23} &= G_{32} = -G_5 \\ G_{13} &= G_{31} = -G_6\end{aligned}$$

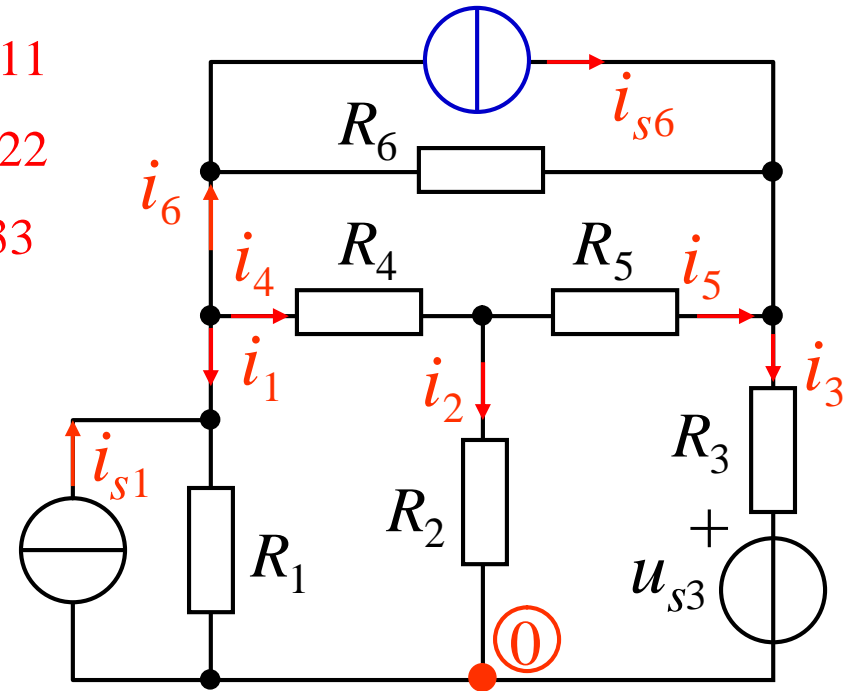

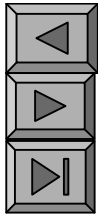

$$(G_1 + G_4 + G_6)u_{n1} \quad G_4u_{n2} \quad G_6u_{n3} = i_{s1} \quad i_{s6}$$

$$G_4u_{n1} + (G_2 + G_4 + G_5)u_{n2} \quad G_5u_{n3} = 0$$

$$G_6u_{n1} \quad G_5u_{n2} + (G_3 + G_5 + G_6)u_{n3} = i_{s6} + G_3u_{s3}$$

$$G_{11}u_{n1} + G_{12}u_{n2} + G_{13}u_{n3} = i_{s11}$$

$$G_{21}u_{n1} + G_{22}u_{n2} + G_{23}u_{n3} = i_{s22}$$

$$G_{31}u_{n1} + G_{32}u_{n2} + G_{33}u_{n3} = i_{s33}$$

$$i_{s11} = i_{s1} - i_{s6} \quad i_{s22} = 0$$

$$i_{s33} = i_{s6} - G_3u_{s3}$$

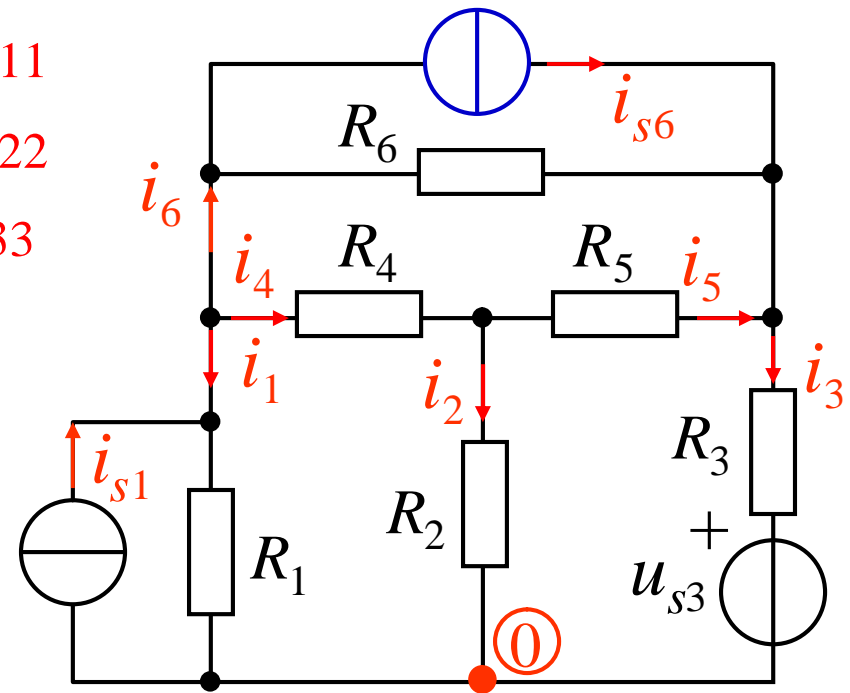

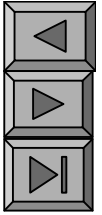

4.

- $n - 1$

$$G_{11}u_{n1} + G_{12}u_{n2} + G_{13}u_{n3} + \dots + G_{1(n-1)}u_{n(n-1)} = i_{s11}$$

$$G_{21}u_{n1} + G_{22}u_{n2} + G_{23}u_{n3} + \dots + G_{2(n-1)}u_{n(n-1)} = i_{s22}$$

$$G_{31}u_{n1} + G_{32}u_{n2} + G_{33}u_{n3} + \dots + G_{3(n-1)}u_{n(n-1)} = i_{s33}$$

.....

$$G_{(n-1)1}u_{n1} + G_{(n-1)2}u_{n2} + G_{(n-1)3}u_{n3} + \dots + G_{(n-1)(n-1)}u_{n(n-1)} = i_{s(n-1)(n-1)}$$

- 

$$G_{ij} = G_{ji}$$

P71 3 5

①

$$\begin{aligned}
 & : (G_1 + G_4 + G_8)u_{n1} \\
 -G_1 u_{n2} - G_4 u_{n4} & = i_{s4} - i_{s13} \\
 & : (G_1 + G_2 + G_5)u_{n2} \\
 -G_1 u_{n1} - G_2 u_{n3} & = 0 \\
 & : (G_2 + G_3 + G_6)u_{n3} \\
 -G_2 u_{n2} - G_3 u_{n4} & = i_{s13} - G_3 u_{s3} \\
 & : (G_3 + G_4 + G_7)u_{n4} - G_4 u_{n1} - G_3 u_{n3} \\
 & = G_3 u_{s3} + G_7 u_{s7} - i_{s4}
 \end{aligned}$$

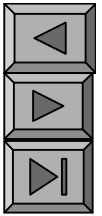
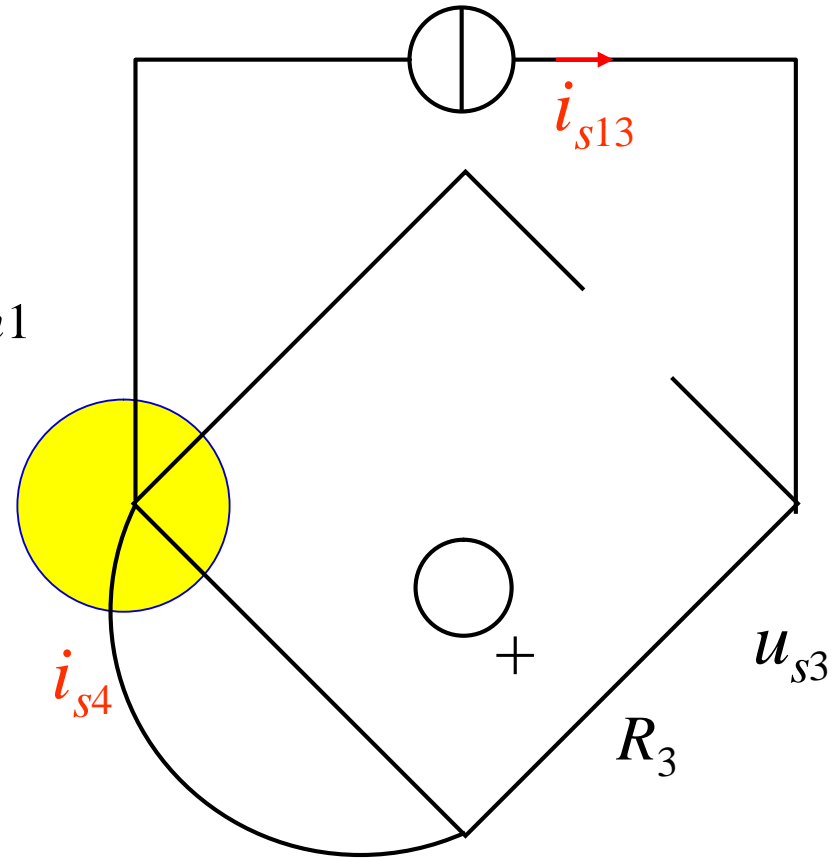

3 6 ( )

5.

P73 3 7

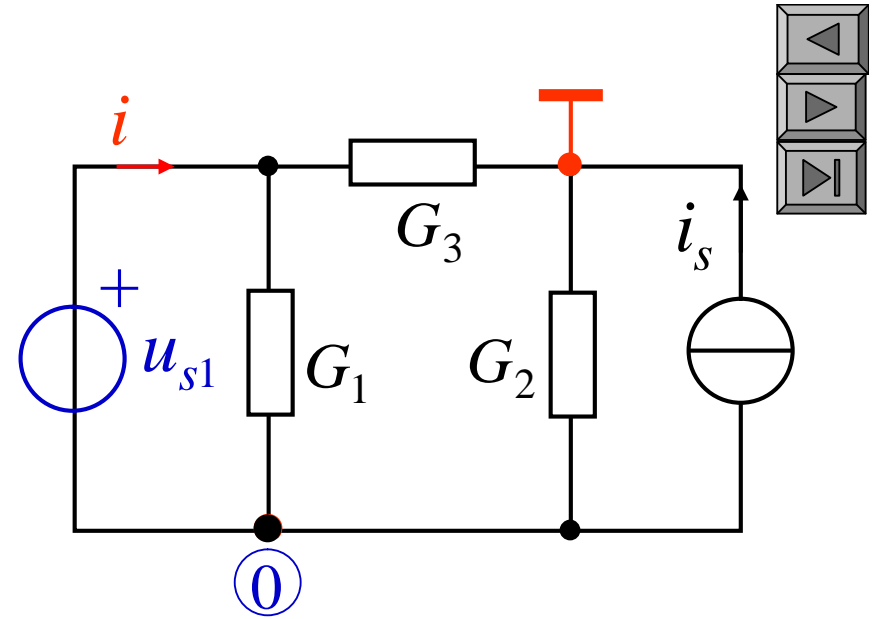

$$(G_1 + G_3)u_{n1} - G_3u_{n2} = i$$

$$-G_3u_{n1} + (G_2 + G_3)u_{n2} = i_{s2}$$

$$u_{n1} = u_{s1}$$

$$u_{s1}$$

$$u_{n1} = u_{s1}$$

$$u_{n2}$$

$$(G_1 + G_3)u_{n1} - G_1u_{n0} = i$$

$$-G_1u_{n1} + (G_1 + G_2)u_{n0} = -i_{s2} - i$$

$$u_{n1} - u_{n0} = u_{s1}$$

3 7

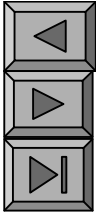

---

---

---

---



6.

P74 3 8

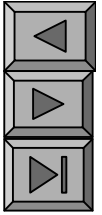

(1)

“0”

$$u_{n1} = u_2$$

(2)

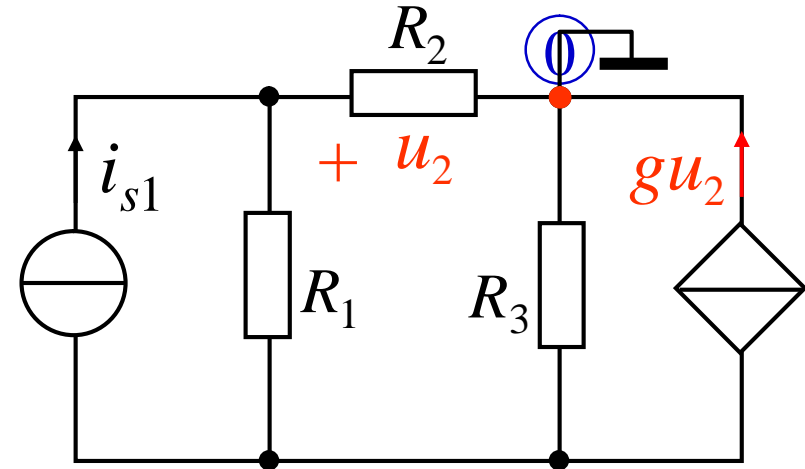

$$\therefore \left( \frac{1}{R_1} + \frac{1}{R_2} \right) u_{n1} - \frac{1}{R_1} u_{n2} = i_{s1} \quad (3)$$

$$\therefore \left( \frac{1}{R_2} + \frac{1}{R_3} \right) u_{n2} = -i_{s1} - gu_{n1}$$

$$\left( -\frac{1}{R_1} + g \right) u_{n1}$$

A pink arrow points from the  $-gu_{n1}$  term in the equation above to the  $g$  term in this equation.

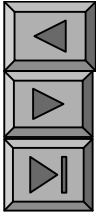

1. ( “-” )

2. :

3.

4.

